

更改 REV	修改内容 MODIFICATION
A	ECXXXX

**SPECIFICATION:**

1. Current Rating: 0.5A
2. Voltage Rating: 25V AC
3. Contact Resistance: 60mΩ max.
4. Insulation Resistance: 500MΩ Min.
5. Dielectric Withstanding Voltage : 125VAC
6. Durability : 25 Cycle
7. Operating Temperature Range : -40°C~+85°C

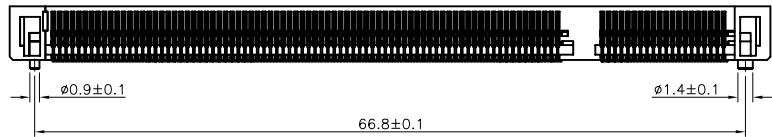
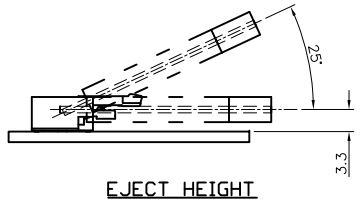
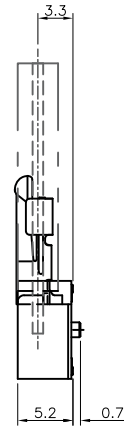
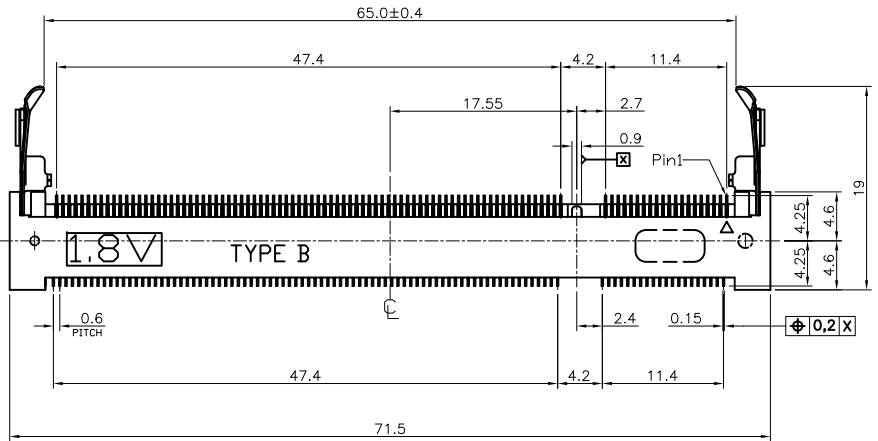
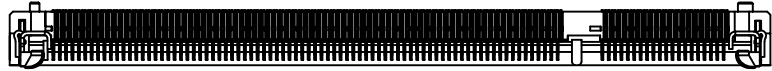

3	METAL LATCH	SUS
2	TERMINAL	PHOSPHOR BRONZE, GOLD PLATED OVER NICKEL
1	HOUSING	LCP, UL94V-0, BLACK
NO.	PART NAME	DESCRIPTION

GENERAL TOLERANCE		KINGCONN 皇海科技股份有限公司
X± 0.50	X*± 5°	
.X± 0.30	.X*± 2°	
.XX± 0.20	.XX*± 1°	名称(TITLE) DDR H5.2 TYPE A Reverse FOR 200PIN BLACK
单位(UNIT) mm	料号(PART NO.) 7DDR2-F0-0006-B	图号(DWG NO.) 7DDR2-F0-0006-B
审核(APPROVAL)	校对(CHECKED)	制图(DRAWN)
比例(SCALE) 1:1		张数(SHEET) 1/4
图注(FIG. NO.)		更改(REV) A



更改 REV	修改内容 MODIFICATION
A	ECXXXXX

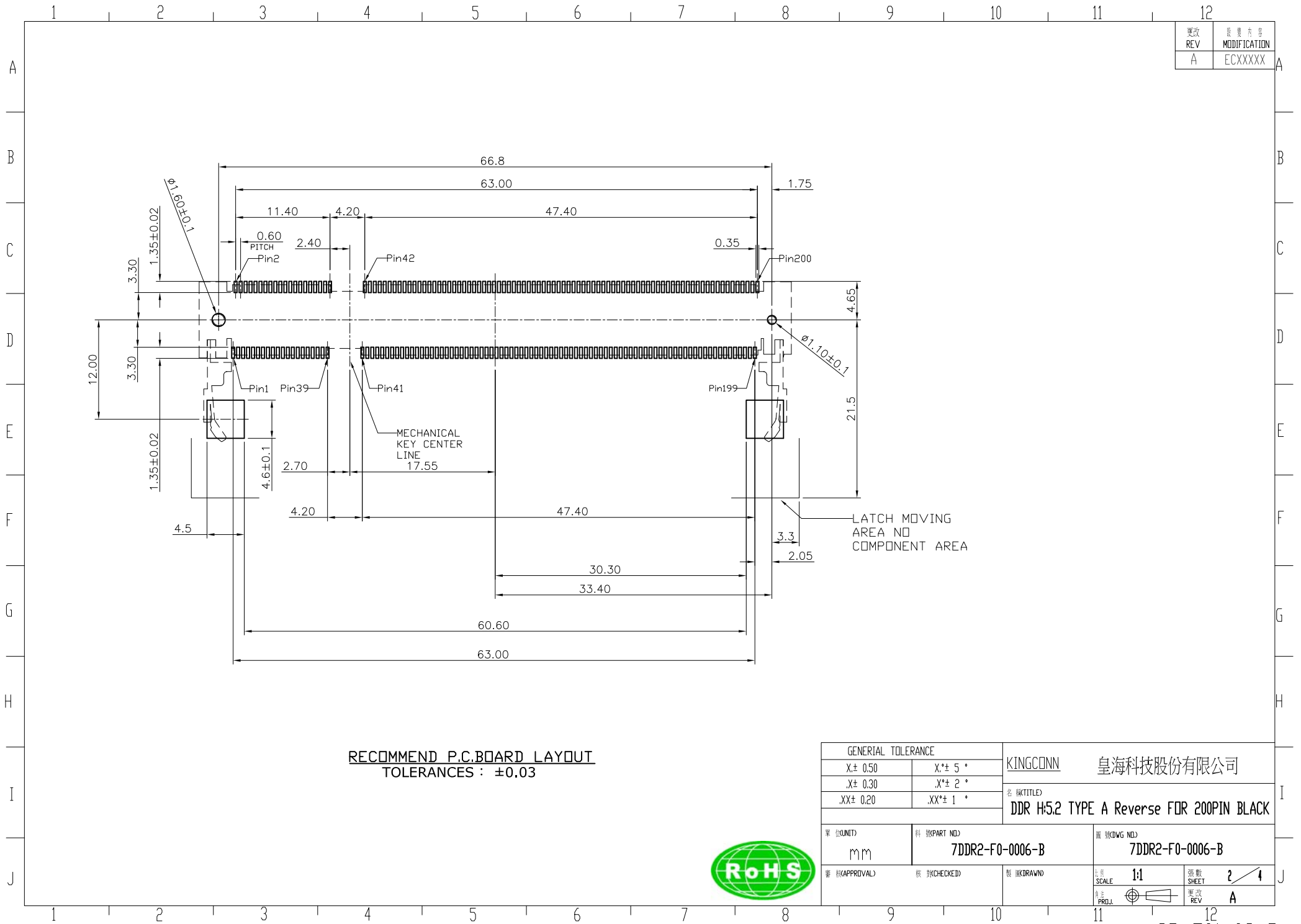

**RECOMMEND P.C. BOARD LAYOUT**  
TOLERANCES : ±0.03

GENERAL TOLERANCE		KINGCONN 皇海科技股份有限公司
X ± 0.50	X° ± 5°	
.X ± 0.30	.X° ± 2°	
.XX ± 0.20	.XX° ± 1°	名 稱(TITLE) DDR H5.2 TYPE A Reverse FOR 200PIN BLACK
單位(UNIT) mm	料號(PART NO.) 7DDR2-F0-0006-B	圖號(DWG NO.) 7DDR2-F0-0006-B
審核(APPROVAL)	核對(CHECKED)	製圖(DRAWN)
		比例(SCALE) 1:1
		張數(SHEET) 2 / 4
		更改(REV) A





更改 REV	變更內容 MODIFICATION
A	ECXXXXX

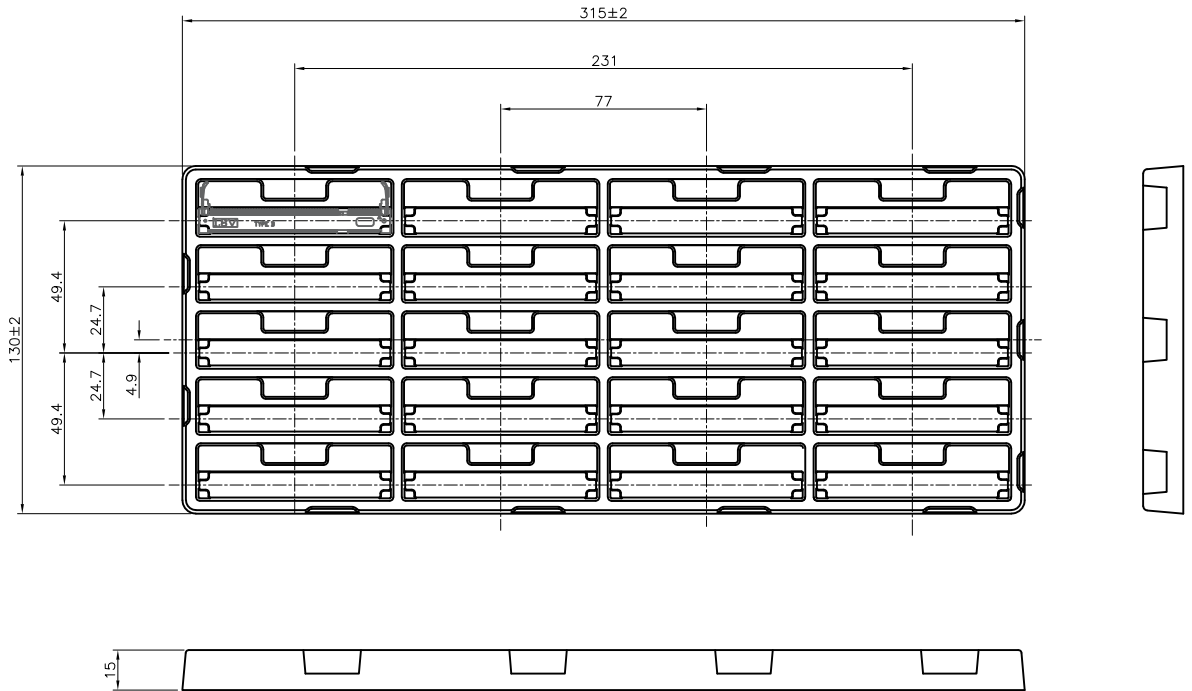

NOTE:

1. 20PCS /Tray
2. 200PCS /Inner Box
3. 600PCS /Carton



GENERAL TOLERANCE		KINGCONN 皇海科技股份有限公司	
X± 0.50	X*± 5 °	名稱(TITLE) DDR H5.2 TYPE A Reverse FOR 200PIN BLACK	
.X± 0.30	.X*± 2 °		
.XX± 0.20	.XX*± 1 °		
單位(UNIT) mm	料號(PART NO.) 7DDR2-F0-0006-B	圖號(DWG NO.) 7DDR2-F0-0006-B	
審核(APPROVAL)	核對(CHECKED)	製圖(DRAWN)	比例(SCALE) 1:1
			張數(SHEET) 1/1
			更改(REV) A