

更改 REV	修改内容 MODIFICATION
A	ECXXXXX

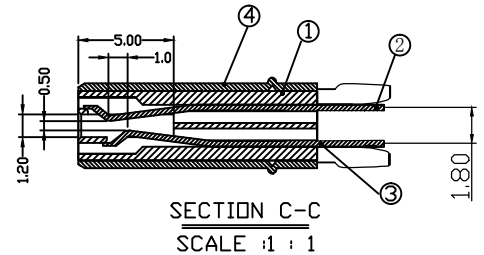

-NOTES-

- Electrical:  
 Contact resistance: 30m ohms max.  
 Dielectric withstanding voltage:  
 500V AC/1 min.  
 Insulation resistance:  
 20M ohms min.
- Mechanical:  
 Mating Force: 44.1N max.  
 Withdrawal Force: 9.8N min.  
 Durability: 1500cycles min.
- Material:  
 Operating Temperature: -25to+85°

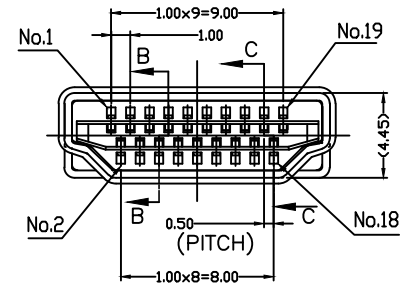
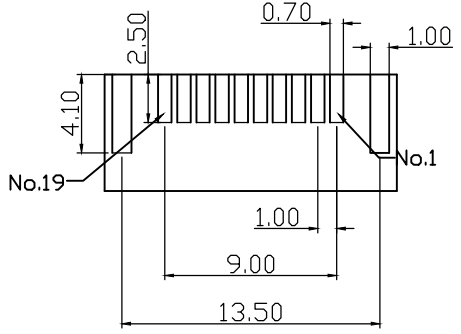
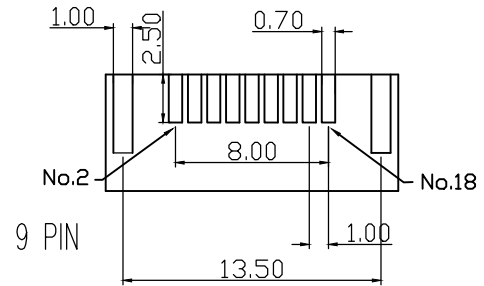
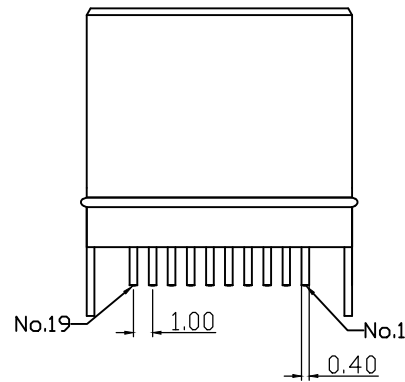
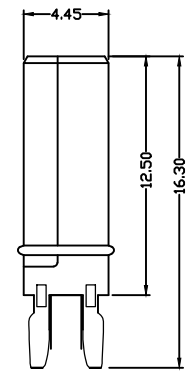
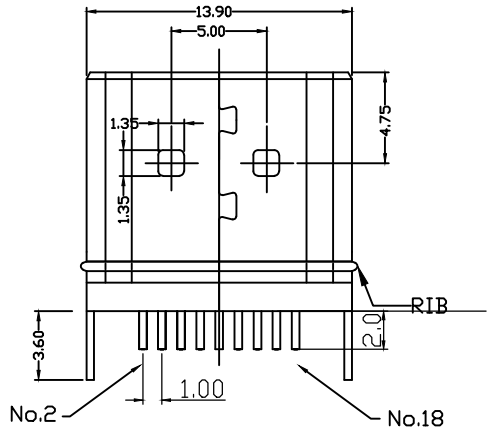

GENERAL TOLERANCE		KINGCONN 皇海科技股份有限公司
X± 0.50	X*± 5°	
.X± 0.30	.X*± 2°	
.XX± 0.20	.XX*± 1°	名 稱(TITLE) HDMI 19P MALE 夾板式
單位(UNIT) mm	料 號(PART NO.) 7HDMI-F0-0017	圖 號(DWG NO.) 7HDMI-F0-0017
審核(APPROVAL)	核 對(CHECKED)	製 圖(DRAWN)
SCALE 1:1		張數 SHEET 1 / 1
PROJ.		更改 REV A