

更改 REV	修改內容 MODIFICATION
A	ECXXXX

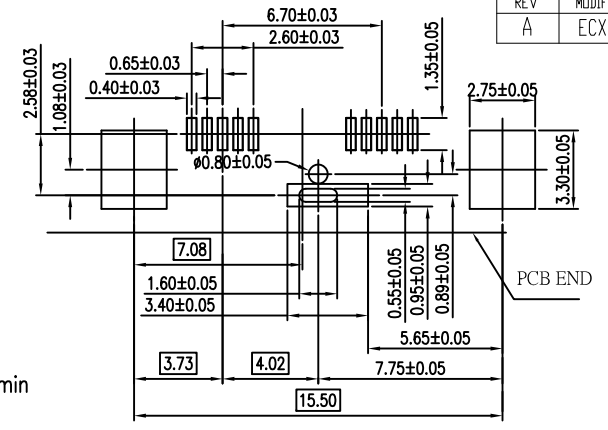

NOTE:  
 1.ELECTRICAL CHARACTERISTICS;  
 1.1 1.8Amps max (for Vbus & GND pins)  
 1.2 0.5Amps max for other pins  
 1.3 Dielectric withstanding voltage : 100 VAC/min  
 1.4 CONTACT RESISTANCE:30mΩ MAX.  
 1.5 RATED CURRENT:0.5A MAX.  
 1.6 RATED VOLTAGE:30V AC MAX.  
 1.7 INSULATION RESISTANCE 100 MΩ MIN.  
 1.8 OPERATING TEMPERATURE:-30°C ~ 85°C  
 2 MECHANICAL CHARACTERISTICS:  
 2.1 MATING FORCE:35N MAX  
 2.2 UNMATING FORCE:10 MIN  
 2.3 DURABILITY:10,000 CYCLES(UNMATING FORCE:8~20N).

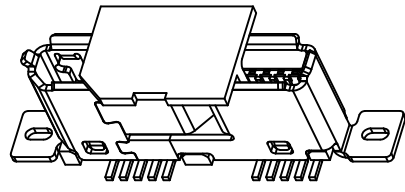
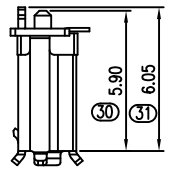
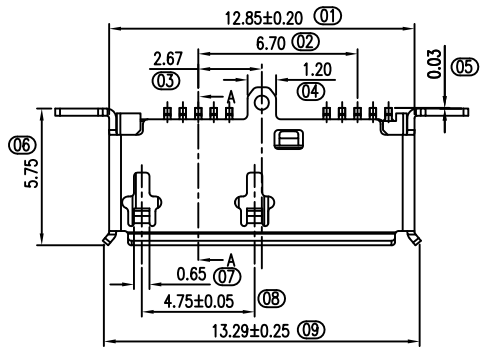
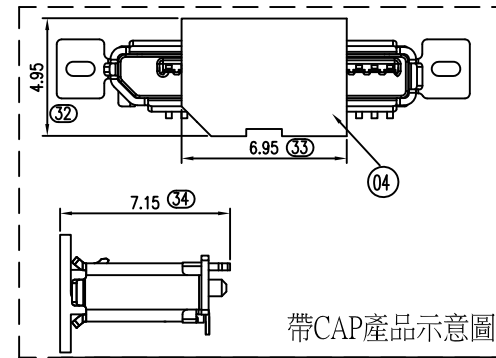
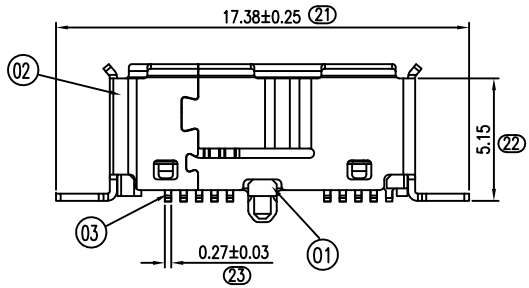
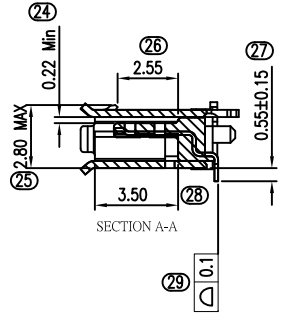
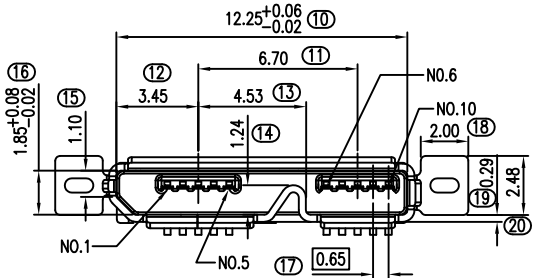

Pin Number	Signal Name
1	VBUS
2	D-
3	D+
4	ID
5	GND
6	MicB_SSTX-
7	MicB_SSTX+
8	GND_DRAIN
9	MicB_SSRX-
10	MicB_SSRX+
Shell	Shield

ITEM	DESCRIPTION	Q'TY	MATERIAL	REMARK
04	CAP	1	LCP-628	UL94V-0; COLOR:BLACK
03	CONTACT	10	BRASS	C2680
02	SHELL	1	SUS304	SUS304
01	HOUSING	1	LCP	UL94V-0; COLOR:BLACK

GENERAL TOLERANCE		KINGCONN 皇海科技股份有限公司
X± 0.50	X*± 5 °	
X± 0.30	X*± 2 °	
.XX± 0.20	.XX*± 1 °	
		名 稱(TITLE) Micro USB 3.0 BF SMT 直立式 H=5.75mm
單 位(UNIT) mm	料 號(PART NO.) 7MCUB-F0-0017	圖 號(DWG NO.) 7MCUB-F0-0017-A
審 核(APPROVAL)	核 對(CHECKED)	製 圖(DRAWN)
		比 例 SCALE 1:1
		張 數 SHEET 1 / 1
		更 改 REV A

